



Indoor Fisheye Dome Hardware Manual

B54, B55, B56

2013/10/31



Table of Contents

Precautions 3

Safety Instructions	5
----------------------------------	----------

Introduction 7

The List of Models	7
Package Contents.....	8
Physical Description	9

Before Installation 10

Prepare the Power Adaptor (Optional).....	10
Prepare the DI/DO Connector (Optional)	12

Installation Procedures 15

Mounting Solutions	15
Mounting on the Ceiling or Wall	17
Step 1: Drill the Holes	17
Step 2: Prepare the Camera	18
Step 3: Install the Camera.....	19
Step 4: Connect the Cable(s).....	19
Step 5: Complete the Installation	21
Step 6: Access the Camera Live View	22

Accessing the Camera 23

Configure the IP Addresses	23
Access the Camera.....	27

Precautions

Read these instructions

You should read all the safety and operating instructions before using this product.

Heed all warnings

You must adhere to all the warnings on the product and in the instruction manual. Failure to follow the safety instruction given may directly endanger people, cause damage to the system or to other equipment.

Servicing

Do not attempt to service this video device yourself as opening or removing covers may expose you to dangerous voltage or other hazards. Refer all servicing to qualified service personnel.

Trademarks

All names used in this manual are probably registered trademarks of respective companies.

Liability

Every reasonable care has been taken during the writing of this manual. Please inform your local office if you find any inaccuracies or omissions. We cannot be held responsible for any typographical or technical errors and reserve the right to make changes to the product and manuals without prior notice.

Federal Communications Commission Statement



This equipment has been tested and found to comply with the limits for a class B digital device, pursuant to Part 15 of the FCC Rules. These limits are designed to provide reasonable protection against harmful interference in a residential installation. This equipment generates, uses, and can radiate radio frequency energy and, if not installed and used in accordance with the instructions, may cause harmful interference to radio communications. However, there is no guarantee that interference will not occur in a particular installation. If this equipment does cause harmful interference to radio or television reception, which can be determined by turning the equipment off and on, the user is encouraged to try to correct the interference by one or more of the following measures:

- Reorient or relocate the receiving antenna.
- Increase the separation between the equipment and receiver.
- Connect the equipment into an outlet on a circuit different from that to which the receiver is connected.
- Consult the dealer or an experienced radio/TV technician for help.

Warning: Changes or modifications to the equipment that are not expressly approved by the responsible party for compliance could void the user's authority to operate the equipment.

European Community Compliance Statement



This product has been tested and found to comply with the limits for Class B Information Technology Equipment according to European Standard EN 55022 and EN 55024. In a domestic environment, this product may cause radio interference in which cause the user may be required to take adequate measures.

Safety Instructions

Don't use the power supply with other voltages

This device is likely to be damaged or damage other equipments / personnel, if you use a power supply with different voltage than the one included with this device. All warranty of this product will be voided in the situations above.

Don't open the housing of the product

Cleaning

Disconnect this video product from the power supply before cleaning.

Attachments

Do not use attachments not recommended by the video product manufacturer as they may cause hazards.

Water and Moisture

Do not use this video product near water, for example, near a bathtub, washbowl, kitchen sink, or laundry tub, in a wet basement, or near a swimming pool and the like.

Don't use accessories not recommended by the manufacturer

Only install this device and the power supply in a dry place protected from weather

Servicing

Do not attempt to service this video product yourself as opening or removing covers may expose you to dangerous voltage or other hazards. Refer all servicing to qualified service personnel.

Damage Requiring service

Disconnect this video product from the power supply immediately and refer servicing to qualified service personnel under the following conditions.

- 1) When the power-supply cord or plug is damaged
- 2) If liquid has been spilled, or objects have fallen into the video product.
- 3) If the video product has been directly exposed to rain or water.
- 4) If the video product does not operate normally by following the operating Instructions in this manual. Adjust only those controls that are covered by the instruction manual, as an improper adjustment of other controls may result in damage, and will often require extensive work by a qualified technician to restore the video product to its normal operation.



Safety Check

Upon completion of any service or repairs to this video product, ask the service technician to perform safety checks to determine if the video product is in proper operating condition.

Introduction







The List of Models

This hardware manual contains the following models:

B54		5MP Indoor Fisheye Dome with D/N, Basic WDR, Fixed lens
B55		10MP Indoor Fisheye Dome with D/N, Basic WDR, Fixed lens
B56		3MP Indoor Fisheye Dome with D/N, Superior WDR, Fixed lens

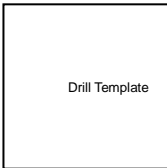
Package Contents

Check if the camera package comes with the following items.

Camera	Screw Kit	Drill Template Sticker
		
Terminal Block (for Power)	Terminal Block (for DI/DO)	Quick Installation Guide
		
Warranty Card		
		

IMPORTANT: When the camera is taken out from the box, the lens is covered by a thin film. DO NOT remove this film. It is used to protect the lens from scratches or fingerprint marks which may happen during installation. Remove this film only after the camera is securely installed and all connections are complete.

Physical Description

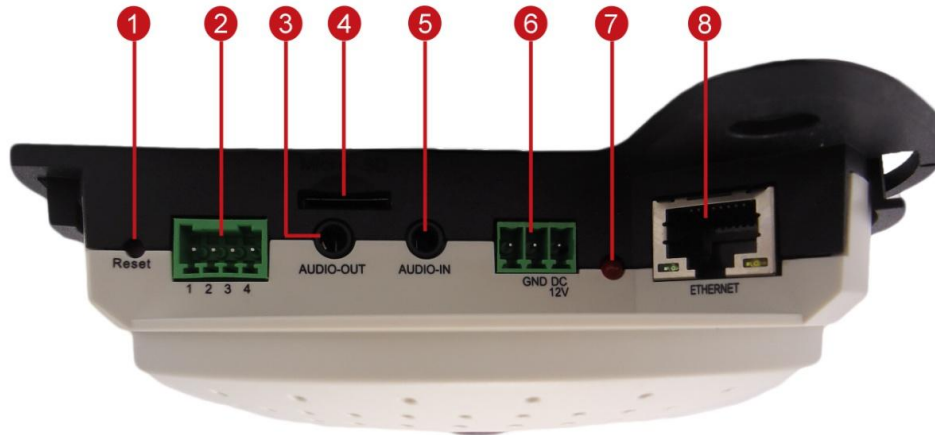

Item	Description
1	Reset Button Used to restore the factory default settings, including the administrator's password. Using a pointed object, such as a pen, press and hold the Reset button for 5 seconds or until the Power LED lights up.
2	Digital Input / Output Connects to digital input or output devices, such as an alarm trigger, panic button, etc. Digital Input (DI) and Digital Output (DO) devices are used in applications like motion detection, event triggering, alarm notifications, etc. See Prepare the DI/DO Connector (Optional) on page 12 for information on how to connect DI/DO devices to your camera.
3	Audio Output Connects to audio output devices, such as a speaker, etc.
4	Micro SDHC Card Slot Insert a micro SDHC card (not included) into the slot for local recording purposes.
5	Audio Input Connects to audio input devices, such as a microphone with built-in amplifier, etc. NOTE: The microphone must have a built-in amplifier. Connecting an ordinary microphone will dwarf sounds and will result in inaudible recording.
6	DC 12V Power Input In case the camera is connected to a non-PoE (Power over Ethernet) switch, use this connector to connect the camera to an external power adaptor. See Prepare the Power Adaptor (Optional) on page 10 for information.
7	Power LED Lights up when the camera is powered on.
8	Ethernet Port Connects to a network using a standard Ethernet cable.

Before Installation

The camera comes with terminal blocks used when an external power adaptor and a digital input/output device are needed to be connected to the camera. The following procedures describe how to connect optional devices to the camera.

Prepare the Power Adaptor (Optional)

In case of using a non-PoE switch or your PoE switch has limited power supply, you can purchase a power adaptor and directly connect the camera to a power outlet. The power adaptor must be connected to the supplied terminal block before use.

To do this, follow the procedures below:

1. Loosen the screws of the **12V** and **GND** pins of the power terminal block.



2. Take note that a standard power adaptor cable has two (2) different wires:

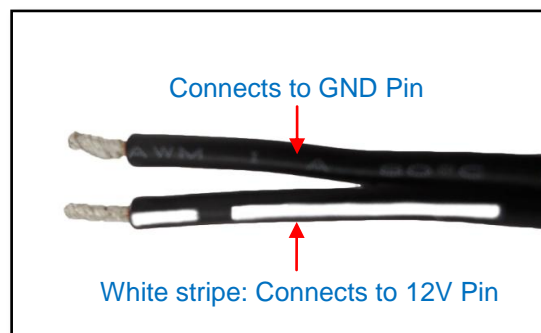

3. Connect the wire with the white stripe to the **12V** pin and the other to the **GND** pin.

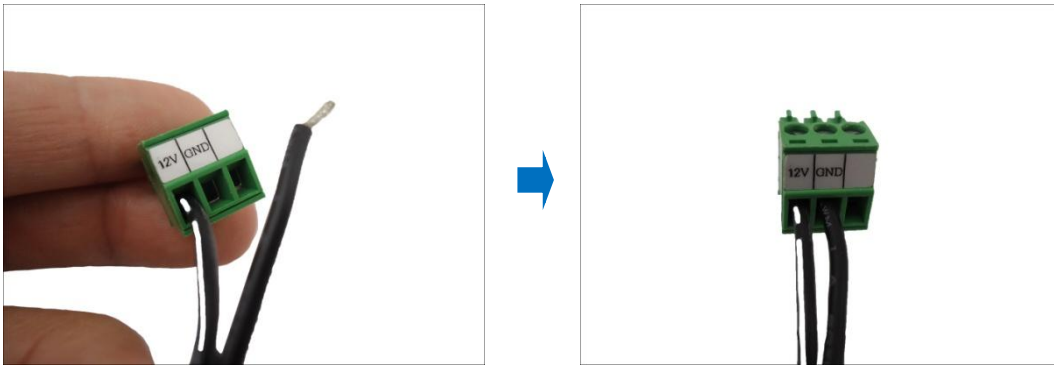

4. Tighten the screws of the **12V** pin and the **GND** pins to secure the wire connection.



5. Set the prepared power adaptor for connection later. Below is an example of a power adaptor with an attached terminal block.



NOTE: The power adaptor is not bundled in the package.

Prepare the DI/DO Connector (Optional)

Depending on your surveillance needs, you may connect digital input or output devices to your camera to trigger events or notifications.

Digital Input (DI) devices can be used to notify the camera about an activity in the camera site. DI can be triggers of events. For example, you can connect a “panic button” to the camera; as such when the panic button is pressed, the alarm signal will be sent through the camera. Other common DI device applications are emergency button, smoke detector, passive infrared sensor, etc.

Digital Output (DO) devices are external devices that are activated by the camera upon an event inside the camera. For example, you can connect an “alarm horn” to the camera; as such when an event occurs inside the camera (e.g. detected intruder), the alarm horn will sound. Other common DO device applications are motion-triggered lights, electric fence, magnetic door locks, etc.

You can connect one DI and one DO device to your camera.

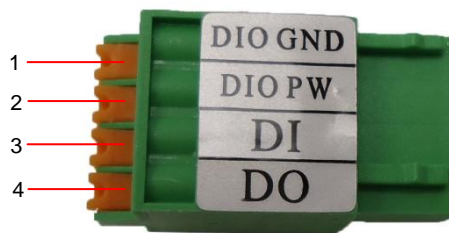

To connect an input (DI) or an output device (DO), map the wires to the pin combinations below:

Device	Pin		Mapping Instructions
Digital Input (DI)	1	DIO GND	Connect the wires of the first input device to DIO GND (Pin 1) and DI (Pin 3).
	3	DI	
Digital Output (DO)	2	DIO PW	Connect the wires of the first output device to DIO PW (Pin 2) and DO (Pin 4).
	4	DO	

The table below shows the DI/DO connection specifications:

Device			
DI	Connection design		TTL - compatible logic levels
	Voltage	To trigger (low)	Logic level 0: 0V ~ 0.4V
		Normal (high)	Logic level 1: 3.1V ~ 30V
	Current		10mA ~ 100mA
DO	Connection design		Transistor (Open Collector)
	Voltage & Current		< 24V DC, < 100mA

Typical Connection

Based on these specifications, if the DI device has a voltage of 0V ~ 30V or the DO device has a voltage of < 24V (<100mA), then the camera can supply internal power to these devices and there is no need to connect the DI/DO device to an external power source.

In this case, wire connection to Pins 1 to 4. Use the **DIO GND** and **DI** pins to connect a DI device and use the **DIO PW** and **DO** pins to connect a DO device. See wiring scheme below:

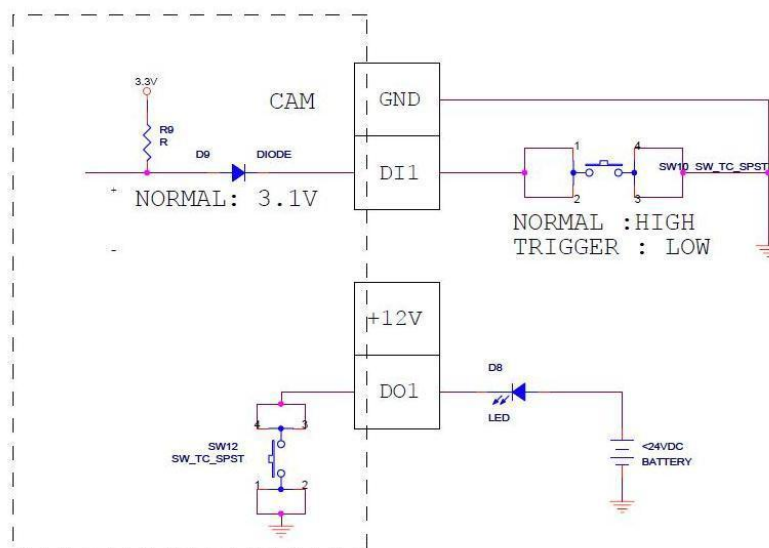

High Voltage DO Device Connection

Even though the camera provides 12V power, this may not be enough for some high voltage DO devices, such as a ceiling light or a motor that opens or closes a gate. In this case, there is a need to connect an external relay. See wiring scheme below:

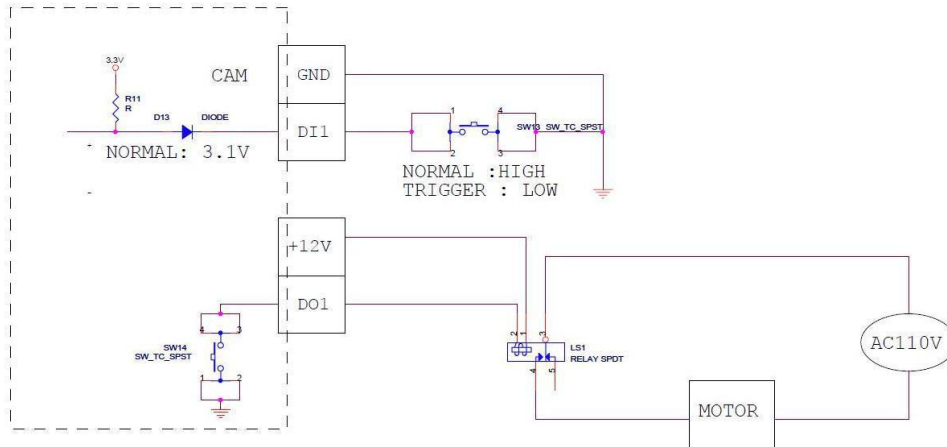

Note that when choosing an appropriate relay, please refer to its specifications and make sure they match the above design. The triggering circuit voltage has to be around 12V DC and the switch-controlled circuit voltage has to match the external power supply (e.g. 110V AC or 220V AC).

The illustration below is a graphic example of connecting a relay to a high voltage DO device.

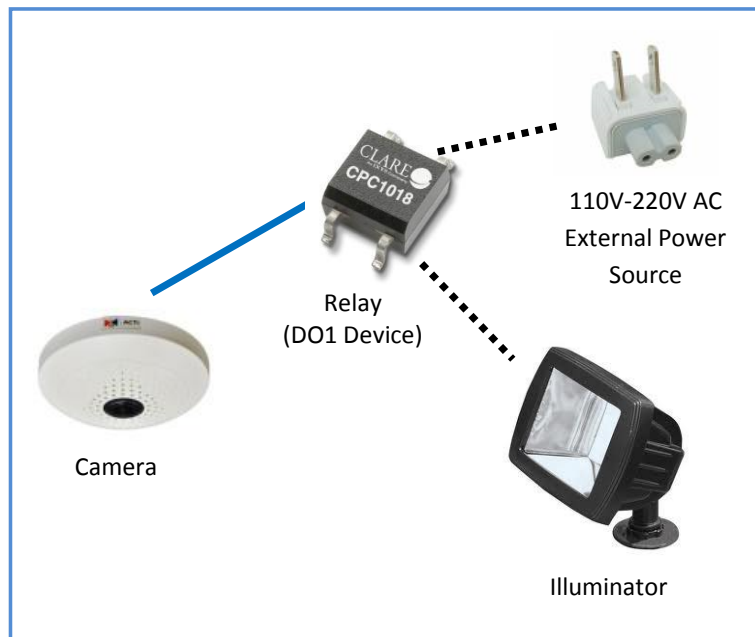

















NOTE: For more information on DI/DO connections, please refer to the article [All about Digital Input and Digital Output](http://www.acti.com/kb/detail.asp?KB_ID=KB20091230001) (http://www.acti.com/kb/detail.asp?KB_ID=KB20091230001) in the Knowledge Base section of our website (www.acti.com).

Installation Procedures

There are several mounting options that you can use to install the camera. Select the most suitable solution for your installation environment.

Mounting Solutions

Mount Types	Accessories
Surface Mount	Directly installs the camera on the surface; no additional mounting accessories required. See Mounting on the Ceiling or Wall on page 17.
Flush Mount	Suitable when mounting the camera discretely above dropped ceilings wherein only the front panel will be visible underneath the ceiling.
	PMAX-1009 
Tilted Wall Mount	Suitable when mounting the camera on high walls. The camera can be tilted 10° to capture a larger viewing angle below the camera and less on the ceiling.
	PMAX-0310 
Pendant Mount	Suitable when mounting the camera on hard and high ceilings.
	PMAX-0101 PMAX-0103   
	PMAX-0101 PMAX-0102   
	PMAX-0101 PMAX-0103   

Mount Types	Accessories
Vertical Pole Mount	Suitable when mounting the camera on a vertical pole.
	<p>PMAX-0310 PMAX-0503</p> 
	<p>PMAX-0101 PMAX-0303 PMAX-0503</p> 
	<p>PMAX-0101 PMAX-0305 PMAX-0503</p> 
Horizontal Pole Mount	Suitable when mounting the camera on a horizontal pole.
	<p>PMAX-0101 PMAX-0102 PMAX-0503</p> 
Corner Mount	Suitable when mounting the camera on a corner area. The camera can also be tilted 10° to capture a larger viewing angle below the camera and less above.
	<p>PMAX-0310 PMAX-0402</p> 

NOTE:

- For more information about the mounting solutions and accessories, please check the *Mounting Accessory Selector* in our website (<http://www.acti.com/mountingselector>).
- The above mounting accessories are not included in the package. Contact your sales agents to purchase.

Mounting on the Ceiling or Wall

Step 1: Drill the Holes

IMPORTANT!

Before drilling the holes on the ceiling or wall, note the direction of the connectors side of the camera, which is also the opposite side of the camera logo. This influences the camera placement and where you should drill the hole where the cables will pass through or how the cables will go along the ceiling or wall. **When installing the camera on the wall**, the connectors side must either be facing up or down.

1. Attach the drill template on the target surface, drill the holes and attach the plastic plugs (if necessary).

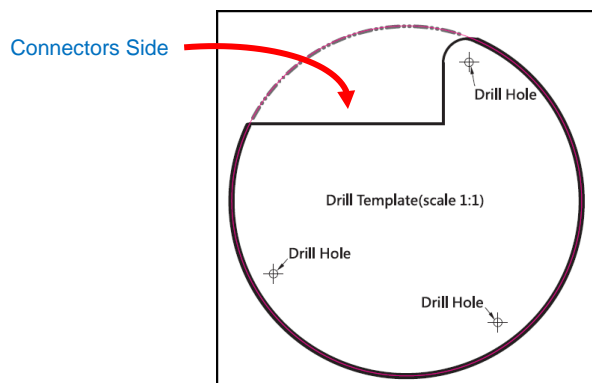

2. **If the cables will pass through the ceiling or wall**, drill also the cable hole at this point and pull the cables through the hole on the ceiling or wall.
3. Remove the drill template sticker from the surface.

Step 2: Prepare the Camera

IMPORTANT: When the camera is taken out from the box, the lens is covered by a thin film. **DO NOT** remove this film. It is used to protect the lens from scratches or fingerprint marks which may happen during installation. Remove this film only after the camera is securely installed and all connections are complete.



1. Slightly twist the cover ring counter-clockwise and pull to detach it.

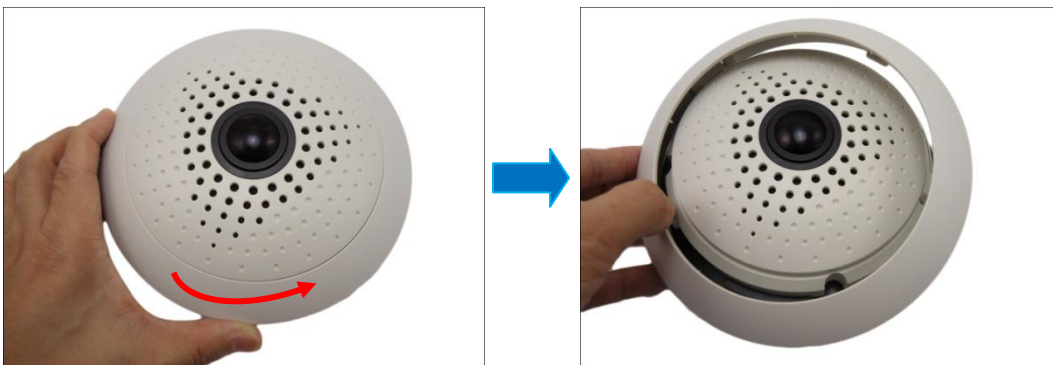

2. **If the cables will be routed along the ceiling or wall**, remove the cable tab from the cover ring. **If the cables will pass through the ceiling or wall**, skip this step.



3. Install a micro SDHC card, as needed, into the micro SDHC card slot of the camera.

Step 3: Install the Camera

Install the camera using the three (3) supplied screws.



Step 4: Connect the Cable(s)

1. Connect the Ethernet cable to the Ethernet port of the camera.
If necessary, connect other cable connectors (optional), like audio input/output, DC 12V power, and DI/DO.

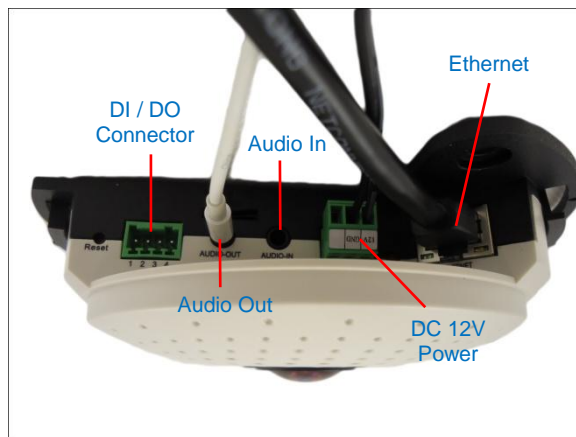

NOTE: The cables are not included in the camera package.

2. On the network side, connect the other end of the Ethernet port to the network switch. As needed, connect the other cables to the corresponding devices as well.

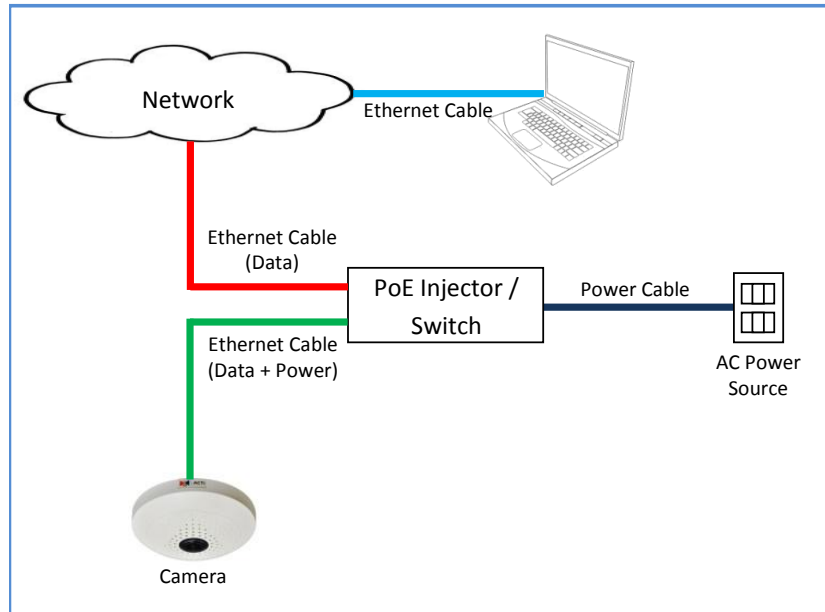

Step 5: Complete the Installation

1. Attach the cover ring, take note that the arrow on the camera should be aligned with the arrow on the cover ring.



NOTE: If the cable(s) will be routed along the ceiling or wall, route the cable(s) through the cable gap of the cover ring.



2. Twist the ring counter-clockwise to secure the ring to the camera.



3. Remove the thin film protecting the lens.



Step 6: Access the Camera Live View

See [Accessing the Camera](#) on page 23 to view the camera Live View and adjust the capture settings or flip the image view.

Accessing the Camera

Configure the IP Addresses

In order to be able to communicate with the camera from your PC, both the camera and the PC have to be within the same network segment. In most cases, it means that they both should have very similar IP addresses, where only the last number of the IP address is different from each other. There are 2 different approaches to IP Address management in Local Area Networks – by DHCP Server or Manually.

Using DHCP server to assign IP addresses

If you have connected the computer and the camera into the network that has a DHCP server running, then you do not need to configure the IP addresses at all – both the camera and the PC would request a unique IP address from the DHCP server automatically. In such case, the camera will immediately be ready for the access from the PC. The user, however, might not know the IP address of the camera yet. It is necessary to know the IP address of the camera in order to access it using a Web browser.

The quickest way to discover the cameras in the network is to use the simplest network search, built in the Windows system – just by pressing the “Network” icon, all the cameras of the local area network will be discovered by Windows, thanks to the UPnP function support of our cameras.

In the example below, the camera that has just been connected to the network is successfully found.

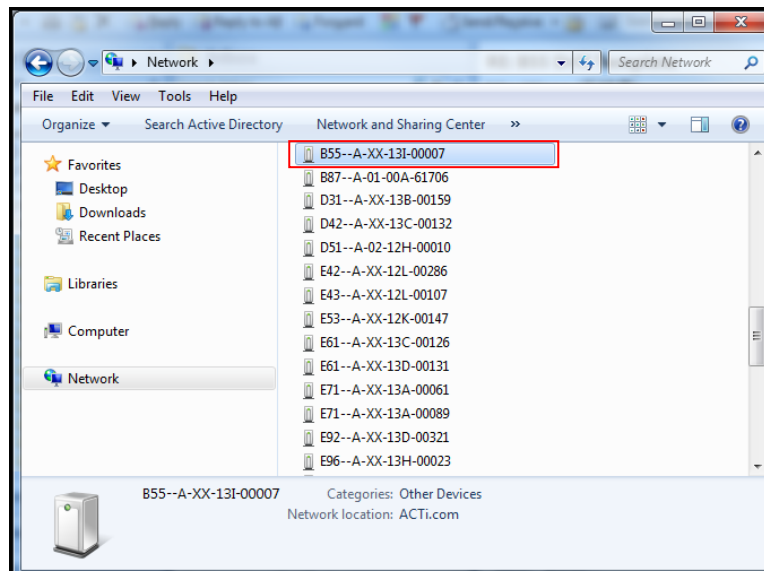

Double-click the mouse on the camera model name, the default browser of the PC is automatically launched and the IP address of the target camera is already filled in the address bar of the browser.

If you work with our cameras regularly, then **there is even a better way to discover the cameras in the network** – by using **IP Utility**. The IP Utility is a light software tool that can not only discover the cameras, but also list lots of valuable information, such as IP and MAC addresses, serial numbers, firmware versions, etc, and allows quick configuration of multiple devices at the same time.

The IP Utility can be downloaded for free from http://www.acti.com/IP_Utility

When you launch IP Utility, the list of connected cameras in the network will be shown. See sample illustration below:

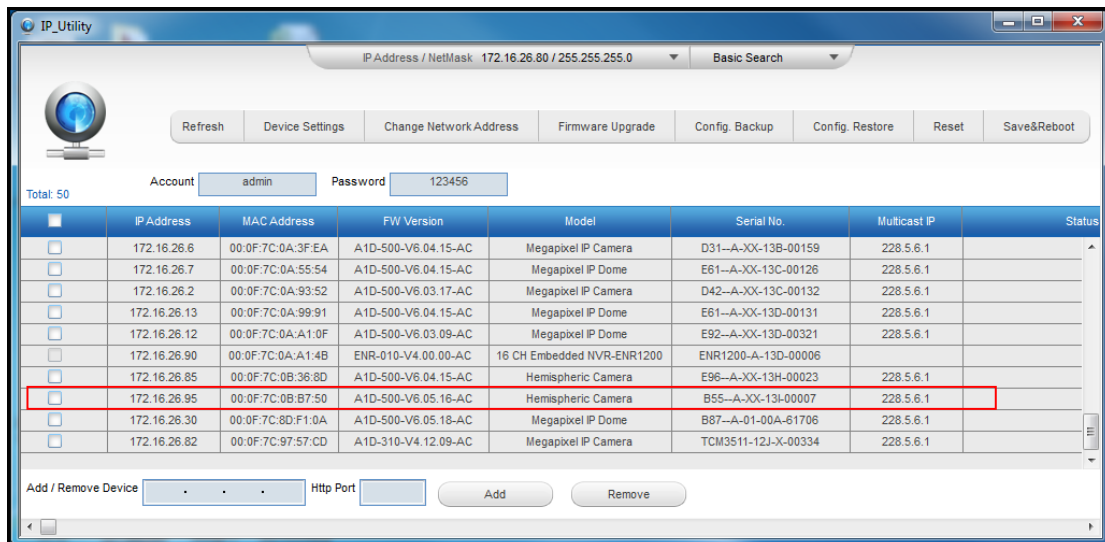

You can quickly notice the camera model in the list. Click on the IP address to automatically launch the default browser of the PC with the IP address of the target camera already filled in the address bar of the browser.

Use the default IP address of the camera

If there is no DHCP server in the given network, the user may have to manually assign the IP addresses to both the PC and the camera to make sure they are in the same network segment.

When the camera is plugged into the network and it does not detect any DHCP services, it will automatically assign itself a default IP:

192.168.0.100

Whereas the default port number would be **80**. In order to access that camera, the IP address of the PC has to be configured to match the network segment of the camera.

Manually adjust the IP address of the PC

In the following example, based on Windows 7, we will configure the IP address to **192.168.0.99** and set Subnet Mask to **255.255.255.0** by using the steps below:

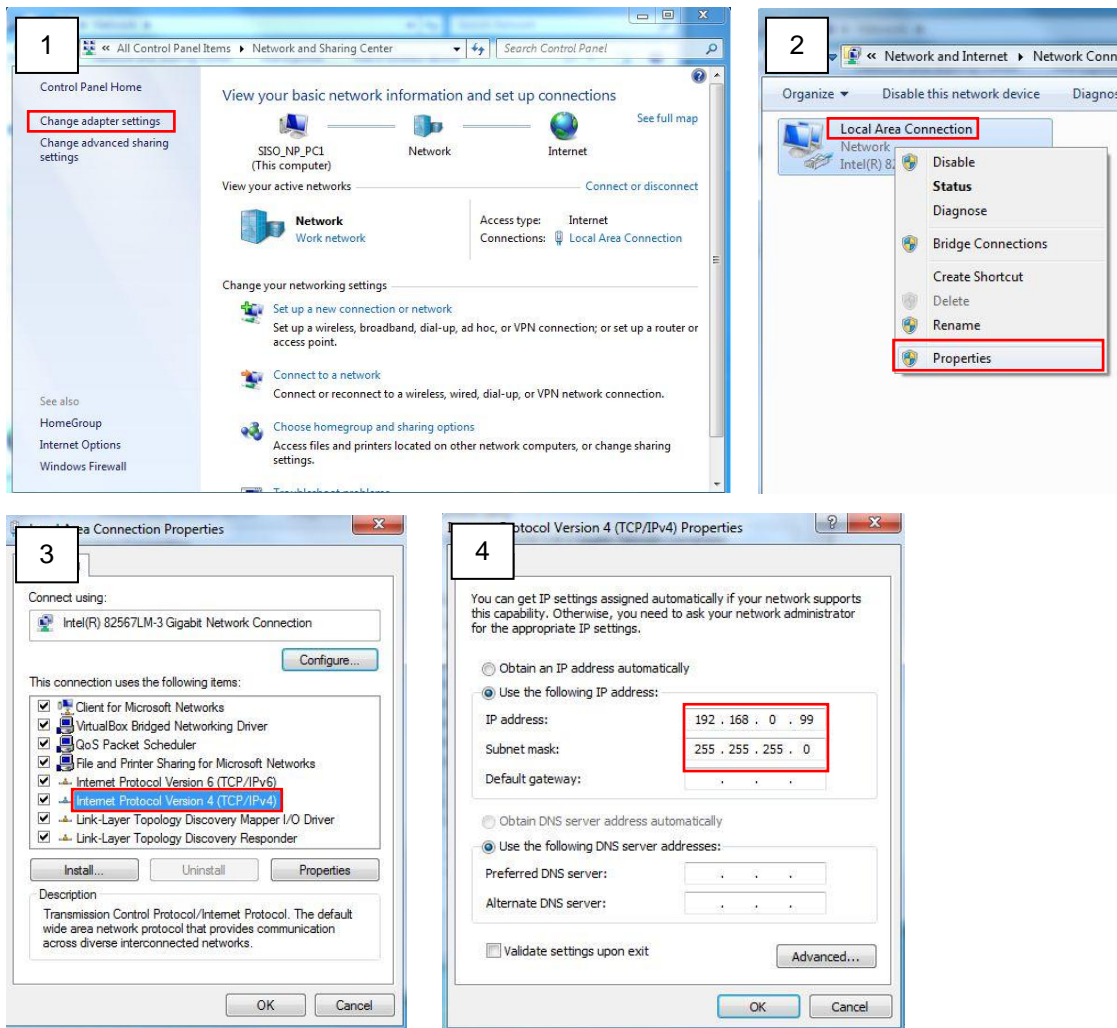

Manually adjust the IP addresses of multiple cameras

If there are more than one camera to be used in the same local area network and there is no DHCP server to assign unique IP addresses to each of them, all of the cameras would then have the initial IP address of **192.168.0.100**, which is not a proper situation for network devices – all the IP addresses have to be different from each other. The easiest way to assign cameras the IP addresses is by using **IP Utility**:

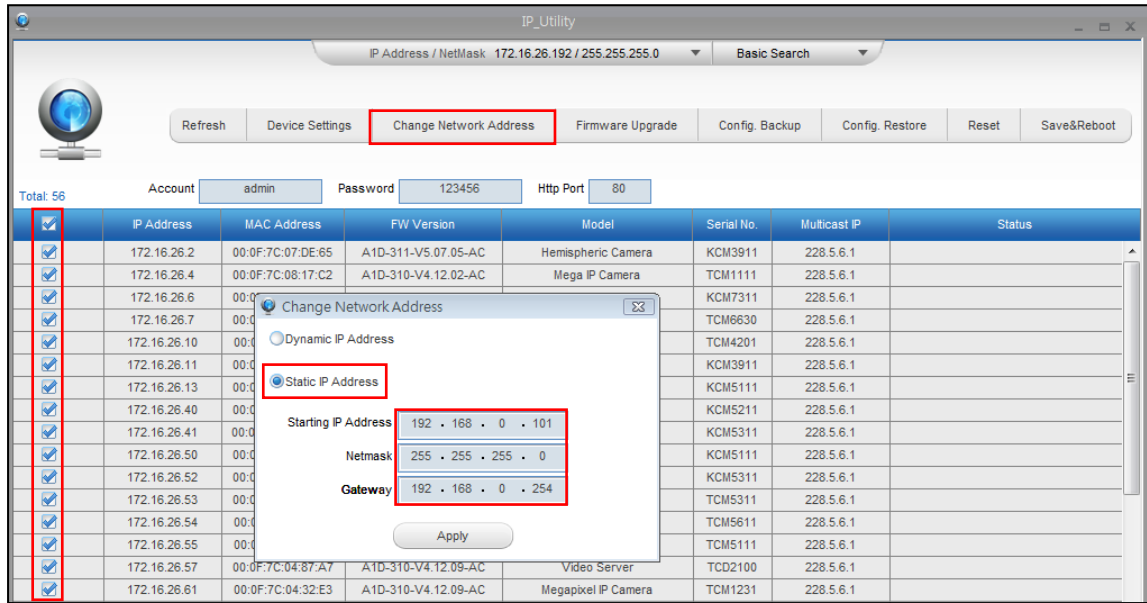

With the procedure shown above, all the cameras will have unique IP addresses, starting from 192.168.0.101. In case there are 20 cameras selected, the last one of the cameras would have the IP 192.168.0.120.

Later, by pressing the “Refresh” button of the IP Utility, you will be able to see the list of cameras with their new IP addresses.



Please note that it is also possible to change the IP addresses manually by using the Web browser. In such case, please plug in only one camera at a time, and change its IP address by using the Web browser before plugging in the next one. This way, the Web browser will not be confused about two devices having the same IP address at the same time.

Access the Camera

Now that the camera and the PC are both having their unique IP addresses and are under the same network segment, it is possible to use the Web browser of the PC to access the camera.

You can use **any of the browsers** to access the camera, however, the full functionality is provided only for **Microsoft Internet Explorer**.

The browser functionality comparison:

Functionality	Internet Explorer	Other browsers
Live Video	Yes	Yes*
Live Video Area Resizable	Yes	No
PTZ Control	Yes	Yes
Capture the snapshot	Yes	Yes
Video overlay based configuration (Motion Detection regions, Privacy Mask regions)	Yes	No
All the other configurations	Yes	Yes

* The basic **VLC media player** (<http://www.videolan.org>) has to be installed in PC first before using any non-Internet Explorer browsers to be able to get live video feed from the camera with those browsers. It is a free and open source cross-platform multimedia player.

***Disclaimer Notice:** The camera manufacturer does not guarantee the compatibility of its cameras with VLC player – since it is a third party software, the third party has the right to modify their utility any time which might affect the compatibility. In such cases, please use Internet Explorer browser instead.*

When using Internet Explorer browser, the ActiveX control for video stream management will be downloaded from the camera directly – the user just has to accept the use of such control when prompted so. No other third party utilities are required to be installed in such case.

The examples in this manual are based on Internet Explorer browser in order to cover all functions of the camera.

Assuming that the camera's IP address is **192.168.0.100**, you can access it by opening the Web browser and typing the following address into Web browser's address bar:

http://192.168.0.100

Upon successful connection to the camera, the user interface called **Web Configurator** would appear together with the login page. The HTTP port number was not added behind the IP address since the default HTTP port of the camera is 80, which can be omitted from the address for convenience.

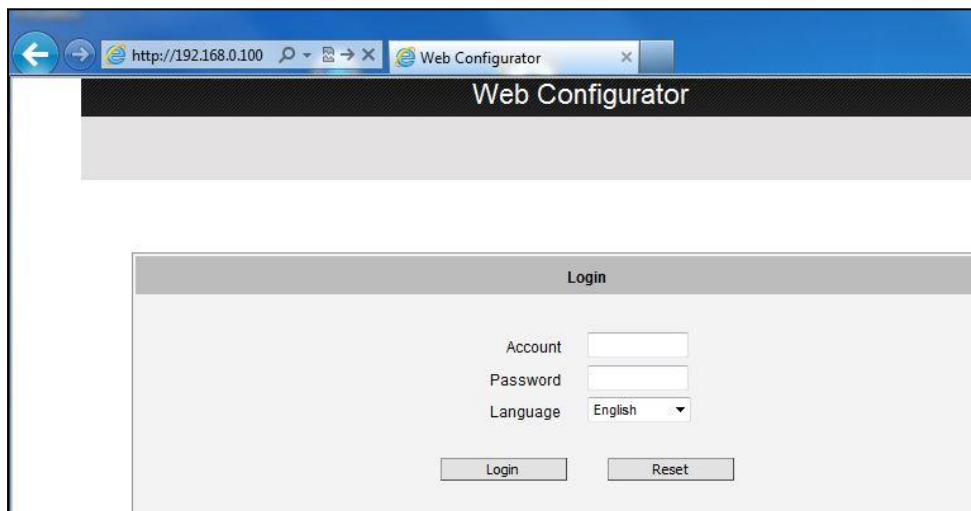

Before logging in, you need to know the factory default Account and Password of the camera.

Account: **Admin**

Password: **123456**

For further operations, please refer to the **Firmware User Manual**.